

Sleep.8

Good Sleep Changes Everything

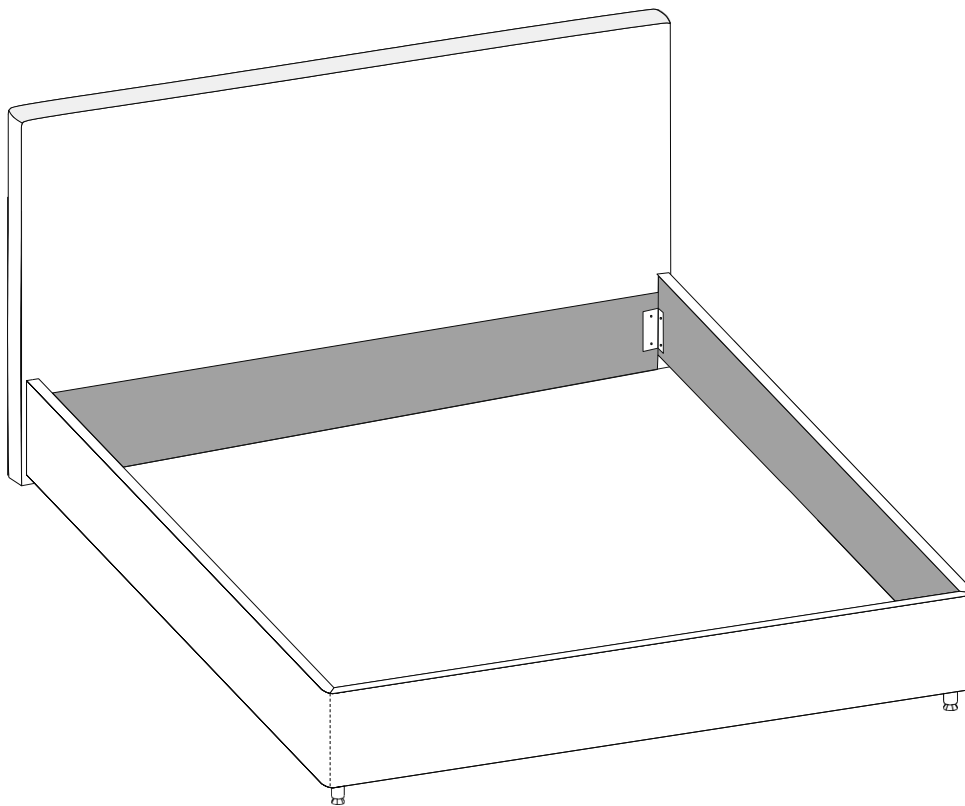

FURNITURE ASSEMBLY INSTRUCTIONS

Manual de montagem de moveis | Instrucciones de montaje |
Möbelmontierungsanweisungen | Οδηγίες συναρμολόγησης επίπλων | Mēbeļu
montāžas instrukcijas | Instrukciuni de asamblarea mobilierului | Mööbli
kokkupanemise juhend



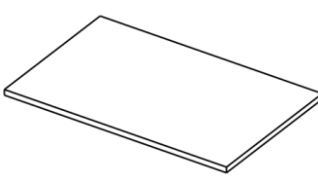
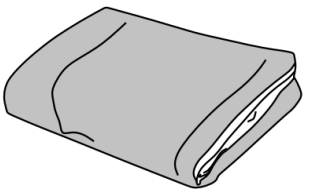
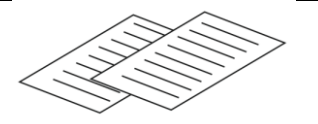
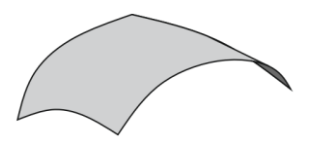
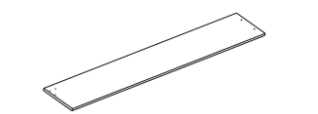
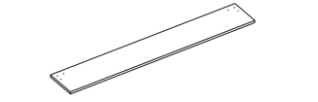

Bed in Basic Configuration | Cama no equipamento base | Βασικό κρεβάτι | Cama estándar (dotación básica) | Bett der | Basiskomplettierung | Gulta ar pamata komplektāciju | Pat de configurație de bază | Algkomplektsuse voodi

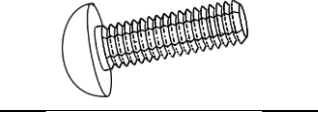
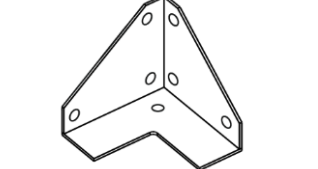
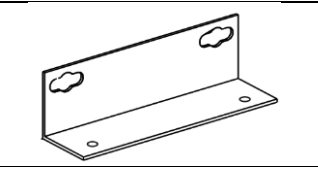
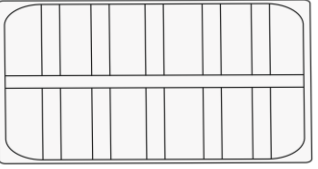

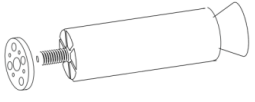

Bed Component list / Lista de peças / Listtado de componentes de la cama / Komplettierungsliste des bettes / Λίστα με υλικά κρεβατιού / Gultas komplektācijas saraksts / Lista pachetelor patului / Voodi komplektsus

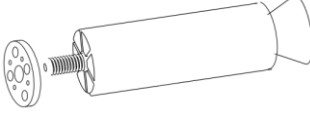

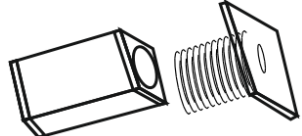
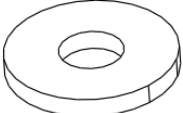
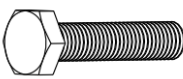
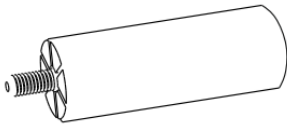
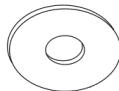
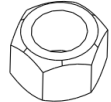
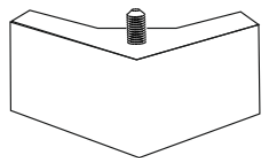
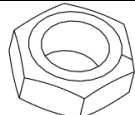

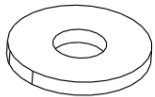
Package	Part	Article	Name	Quantity
Package No. 1 Embalaje no. 1 Embalagem nº 1 Verpackung №1 Συσκευασία υπ'άρ. 1 Iepakojums Nr. 1 Pachetul nr. Pakend nr 1		K01	Headboard/ Respaldo/ Cabeceira/ Lehne/ Πίσω στήριγμα/ Atzveltne/ Tāble/ Seljatugi	1
		K09	Funda para el bastidor (*para camas con funda extraible) / Capa para as barras (*para as camas com capa removível) / Bezug für Zargen (Nur für Betten mit einer Hebevorrichtung und Zargen, die völlig mit Padding bezogen sind) / Κάλυμμα για το σφάγιο / Apaļtapa pārvalks / Acoperire pentru cadru (*pentru paturi cu acoperire detașabilă) / Kate tsargadele (*eemaldatava kattega vooditele)	1
			Instructions for use / Instrucciones de uso / Instrucciones para el Ensamble / Bedienungsanleitung / Εγχειρίδιο χρήστη / Lietotāja rokasgrāmata / Instrucțiuni de utilizare / Kasutusjuhend	1
			Sample of material (*or sewn into cover for braces see pt. p.38) / Muestra de tejido (*puede estar cosida a la funda del bastidor, véase paso 38) / Amostra de material (ou cosido na capa, ver ponto 38) / Stoffmuster (*oder in den Bezug der Zargen eingenäht, siehe Punkt 38) / Δείγμα υφάσματος (*ή ραμμένο στο κάλυμμα του πλαισίου, βλέπε παράγραφο 38) / Auduma paraugs (*vai iezūts apaļtapa pārvalkā sk. p. 38) / Eșantion de țesătură(*sau este cusut în acoperirea cadrului, vezi punctul 38) / Kanga näidis (*või õmmeldud tsargade katesse, vt punkt 38)	1
Package No. 2 Embalaje no. 2 Embalagem nº 2 Verpackung №2 Συσκευασία υπ'άρ. 2 Iepakojums Nr. 2 Pachetul nr. 2 Pakend nr 2		K02	Side Rail / Lateral del bastidor / Barra lateral / Seitenzarge / Πλαϊνό σφάγιο / Sānu apaļtapa / Cadru lateral / Kültsarga	2
		K03	Footboard brace / Pie del bastidor / Traversa peseira / Zarge des Fußendes / Μεσαίο σφάγιο / Vidējā apaļtapa / Cadru piciorului / Jalutse tsarga	1
			Assembly Instructions / Instrucciones de montaje / Manual de montage / Montierungsanweisungen / Οδηγίες συναρμολόγησης / Montāžas darbu instrukcija / Instrucțiuni de asamblarea	1
Package with Fittings Paquete con accesorios Saco com acessórios Verpackung mit Beschlägen Πακέτο εξαρτημάτων επίπλων Soma ar piederumiem Pachet cu accesorii Pakend furnituuriga		KF01	Screw M6x20 / Tornillo M6x20 / Parafuso M6x20 / Schraube M6x20 / Βίδα M6x20 / Šurub M6x20 / Kruvi M6x20	16
		KF23	Angle bracket / Esquinero para los largueros / Canto dos elementos conectivos / Zargenwinkel / Αγκύλη / Bară unghiulară pentru cadru / Tsarga nurk	2
		KF22	Corner connection/ Canto de cabeceira e travessia / Esquinero para el Cabecero / Lehnwinkel/ Γωνιακή σύνδεση/ Bară unghiulară pentru tăble / Seljatoe nurk	2
Package Embalaje (opción adicional) Embalagem (Além disso) Verpackung Pachetul nr. 3 (opțiune suplimentară) Pakend №3 (täiendav)			Bed Base / Estrado da cama / Somier/ Metallrahmen / Βάση κρεβατιού/Gultas pamatne / Baza patului/ Voodi alus /	1

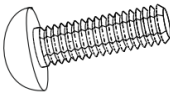
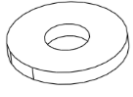
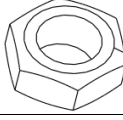
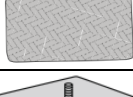
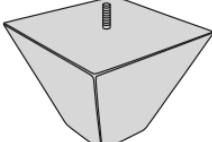
		<p>Legs. Leg configuration depends on the bed model demonstrated as a sample in the store or on the web-side (please see the leg component list) / Pata. El diseño de las patas depende del modelo de cama mostrado en la tienda o el sitio web (Véase el listado de patas y sus componentes) / Pés. Modificação dos pés depende do modelo da cama, fornecido como exemplo no salão ou no site (ver lista de peças dos pés) / Füße. die Modifikation der Füße hängt vom Bettmo-del ab, das als muster im Möbelsalon oder auf der Webseite präsentiert wurde. (siehe die Komplettierungsliste der Füße) / Πόδι α. Η τροποποίηση των ποδιών εξαρτάται από το μοντέλο του κρεβατιού που παρουσιάζεται ως δείγμα στο σαλόνι ή στον ιστότοπο (βλ. τη λίστα υπάρχοντων ποδιών) / Kājiņa. Kājiņu modifikācija ir atkarīga no apaļtaru sešības un veida (skatīt kājiņu komplektācijas sarakstu) / Picioare. modificarea picioarelor depinde de modelul de pat prezentat ca eșantion în salon sau pe site (a se vedea lista completă a picioarelor) / Jalad. Jalade modifikatsioon oleneb salongis või kodulehel näidisedena toodud voodi mudelist (vt jalgade kompleksus)</p>	1 set
--	--	---	-------

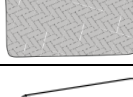
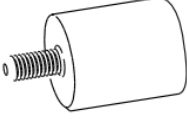
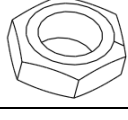
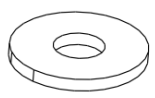
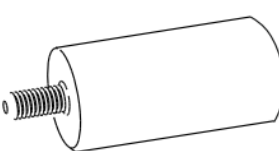
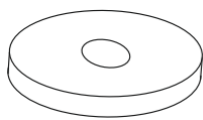
Leg Parts List / Lista de peças para os pés / Listado de patas y sus componentes / Komplettierungsliste der Füße / Λίστα με υλικό Πόδια / Kājiņas komplektācijas saraksts / Lista pachetelor de picioare / Jalgade kompleksus

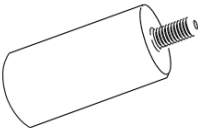
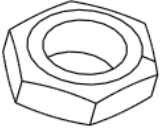
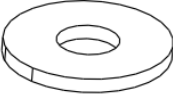
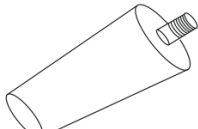
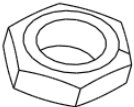
Package	Part	Article	Name	Quantity
<p>Leg Parts No.1 Conjunto de pés №1 Modelo de pata nº 1 Komplettierung der Füße №1 Επιλογή για σετ ποδιών υπ' άρ. 1 Kājiņu komplektācijas variants Nr. 1 Set complet de picioare nr. 1 Jalgade kompleksuse valik nr 1</p>		KF16	<p>Bed Leg Supporting Leg Chrome Boyard-100/ Pé para cama Pé-suporte cromo Boyard-100/ Pata para cama de cromo Boyard-100/ Bettfuß Stütze Chrom-Bojard h-100/ Υποστήριξη χρώμιο Boyard-100/ Balsts hrom Bojard-100/ Picior pentru paturi Picior-suport crom Boyard-100/ Voodijalg Tugijalg kroom Bojard-100</p>	2
		KF29	<p align="center">Allen Key/ Chave Allen/ Llave Allen/ Inbus-Schlüssel/ Εξάγωνο κλειδί/ Atslēga sešstūra/ Cheie hexagonală/ Kuuskantvõti</p>	1
<p>Leg Parts No.2 Conjunto de pés №2 Modelo de pata nº 2 Komplettierung der Füße №2 Επιλογή για σετ ποδιών υπ' άρ. 2 Kājiņu komplektācijas variants Nr. 2 Set complet de picioare nr. 2 Jalgade kompleksuse valik nr 2</p>		KF36	<p align="center">Plastic Leg Square/ Pé plástico cuadrado /Pata cuadrada de plastic/ Plastikfuß Quadrat / Πλαστικό τετράγωνο πόδι/ Plastikāta kājiņa kvadrāts/ Picior pătrat din plastic/ Plastikust jalg ruut</p>	2
		KF40	<p align="center">Washer M8 / Porca M8 /Arandela M8 /Scheibe M8 / Πλυντήριο M8 /Paplāksne M8 / Şaibă M8/ Seib M8</p>	2
		KF38	<p align="center">Bolt M8x10/ Perno M8x10/ Tornillo M8x10/ Bolzen M8x10/ Μπουλόνι M8x10/ Skrūve M8x10/ Şurub M8x10/ Polt M8x10</p>	2
<p>Leg Parts No.3 Conjunto de pés №3 Modelo de pata nº 3 Komplettierung der Füße №3 Επιλογή για σετ ποδιών υπ' άρ. 3 Kājiņu komplektācijas variants Nr. 3 Set complet de picioare nr. 3 Jalgade kompleksuse valik nr 3</p>		KF54	<p>Bed Leg No.1156 Chrome h-150 (pin 8 mm) / Pés para as camas N°1156 cromo h-150 (8mm) / Pata para cama nº 1156 de cromo h-150 (diém. 8 mm)/ Bettfuß №1156 Chrom h-150 / Πόδι για κρεβάτια χρώμιο h-150 (φουρκέτα 8mm) / Gultas kājiņa hroms h-150 (tapskrūve 8mm) / Picior pentru paturi nr. 1156 crom h-150 (pin 8 mm) / Voodi jalg nr 1156 kroom h-150 (tikkpolt 8 mm)</p>	2
		KF40	<p align="center">Washer M8 DIN 126 Porca M8 DIN 126 /Arandela M8 DIN 126 /Scheibe M8 DIN 126 / Πλυντήριο M8 DIN 126 /Paplāksne M8 DIN 126 /Şaibă M8 DIN 126 /Seib M8 DIN 126</p>	2
		KF39	<p align="center">Nut M8 DIN 936 / Tuerca M8 DIN 936 /Porca de parafuso M8 DIN 936 / Mutter M8 DIN 936 / Καρύδι M8 DIN 936 /Uzgrieznis M8 DIN 936 /Piuliņa M8 DIN 936 /Mutter M8 DIN 936</p>	2
		KF31	<p align="center">Angled Wooden Leg h-97 Pé de madeira h-97 angular Pata esquinera de madera h-97 / Holzfuß h-97 Seitenfuß / Εόλινο πόδι γωνίας h-97 Koka kājiņa h-97 stūra Picior din lemn h-97 unghiular Puidust jalg h-97 nurgeline</p>	2
		KF39	<p align="center">Nut M8 DIN 936 / Tuerca M8 DIN 936 /Porca de parafuso M8 DIN 936 / Mutter M8 DIN 936 / Καρύδι M8 DIN 936 /Uzgrieznis M8 DIN 936 /Piuliņa M8 DIN 936 /Mutter M8 DIN 936</p>	2

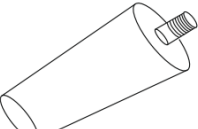
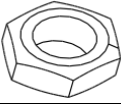
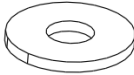
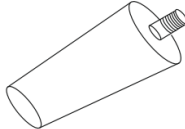
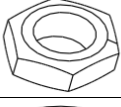
<p>picioare nr. 4 Jalgade komplektsuse valik nr 4</p>		KF40	<p>Washer M8 DIN 126 / Porca M8 DIN 126/ Arandela M8 DIN 126/ Scheibe M8 DIN 126/ Πλυντήριο M8 DIN 126/ Paplāksne M8 DIN 126/ Šaibā M8 DIN 126/ Seib M8 DIN 126</p>	2
		KF18	<p>Felt Damper/ Amortecedor de feltro/ Fieltro protector/ Filziger Dampfer/ Αποσβεστήρας από τσόχα/ Filca amortizators/ Amortizor din pāslā / Vildist amortisaator</p>	4
<p>Leg Parts No.5 Conjunto de pés №5 Modelo de pata n° 5 Komplettierung der Füße №5 Επιλογή για σεντ ποδιών υπ' άρ. 5 Kājiņu komplektācijas variants Nr. 5 Set complet de picioare nr. 5 Jalgade komplektsuse valik nr 5</p>		KF41	<p>Decorative Support h-130 Chrome/ Suporte decorativo h-130 cromo/ Soporte decorative de cromo h-130/ Dekorative Stütze h- 130 Chrom/ Διακοσμητικό στήριγμα χρώμο h-130/ Dekorativs balsts h-130 hroms/ Suport decorativ h-130 crom/ Dekoratiivne tugi h-130 kroom</p>	2
		KF43	<p>Screw M8x20 DIN 967 / Perno M8x20 DIN 967 / Tornillo M8x20 DIN 967 / Bolzen M8x20 DIN 967 / Βίδα M8x20 DIN 967 / Skrūve M8x20 DIN 967 / Šurub M8x20 DIN 967 / Kruvi M8x20 DIN 967</p>	2
		KF42	<p>Washer M8 DIN 9021 / Porca M8 DIN 9021 / Arandela M8 DIN 9021 / Scheibe M8 DIN 9021 / Πλυντήριο M8 DIN 9021 / Paplāksne M8 DIN 9021 / Šaibā M8 DIN 9021 / Seib M8 DIN 9021</p>	2
		KF39	<p>Nut M8 DIN 936 / Tuerca M8 DIN 936 / Porca de parafuso M8 DIN 936 / Mutter M8 DIN 936 / Καρύδι M8 DIN 936 / Uzgrieznis M8 DIN 936 / Piuliņā M8 DIN 936 / Mutter M8 DIN 936</p>	2
		KF18	<p>Felt Damper / Amortecedor de feltro / Fieltro protector / Filziger Dampfer / Αποσβεστήρας από τσόχα / Filca amortizators / Amortizor din pāslā / Vildist amortisaator</p>	1
<p>Leg Parts No.6 Conjunto de pés №6 Modelo de pata n° 6 Komplettierung der Füße №6 Επιλογή για σεντ ποδιών υπ' άρ. 6 Kājiņu komplektācijas variants Nr. 6 Set complet de picioare nr. 6 Jalgade komplektsuse valik nr 6</p>		KF30	<p>Wooden Leg h-97 / Pé de madeira h-97 / Pata de madera h-97 / Holzfuß h-97 / Ξύλινο πόδι h-97 / Koka kājiņa h-97 / Picior din lemn h-97 / Puidust jalg h-97</p>	2
		KF39	<p>Nut M8 DIN 936 / Tuerca M8 DIN 936 / Porca de parafuso M8 DIN 936 / Mutter M8 DIN 936 / Καρύδι M8 DIN 936 / Uzgrieznis M8 DIN 936 / Piuliņā M8 DIN 936 / Mutter M8 DIN 936</p>	2
		KF40	<p>Washer M8 DIN 126 / Porca M8 DIN 126 / Arandela M8 DIN 126 / Scheibe M8 DIN 126 / Πλυντήριο M8 DIN 126 / Paplāksne M8 DIN 126 / Šaibā M8 DIN 126 / Seib M8 DIN 126</p>	2
		KF18	<p>Felt Damper / Amortecedor de feltro / Fieltro protector / Filziger Dampfer / Αποσβεστήρας από τσόχα / Filca amortizators / Amortizor din pāslā / Vildist amortisaator</p>	2
<p>Leg Parts No.7 Conjunto de pés №7 Modelo de pata n° 7 Komplettierung der Füße №7 Επιλογή για σεντ ποδιών υπ' άρ. 7 Kājiņu komplektācijas variants Nr. 7 Set complet de picioare nr. 7 Jalgade komplektsuse valik nr</p>		KF55	<p>Bed Leg 178 Chrome h-50 / Pés para as camas 178 cromo h-50 / Pata para cama 178 de cromo h-50 / Bettfuß 178 Chrom h-50 / Πόδι για κρεβάτια 178 χρώμο h- 50 / Gultas kājiņa 178hroms h-50 / Picior pentru paturi 178 crom h-50 / Voodi jalg 178kroom h-50</p>	2
		KF39	<p>Nut M8 DIN 936 / Tuerca M8 DIN 936 / Porca de parafuso M8 DIN 936 / Mutter M8 DIN 936 / Καρύδι M8 DIN 936 / Uzgrieznis M8 DIN 936 / Piuliņā M8 DIN 936 / Mutter M8 DIN 936</p>	2
		KF40	<p>Washer M8 / Porca M8 / Arandela M8 / Scheibe M8 / Πλυντήριο M8 / Paplāksne M8 / Šaibā M8 / Seib M8</p>	2
<p>Leg Parts No.8 Conjunto de pés №8 Modelo de pata n° 8 Komplettierung der Füße №8 Επιλογή για σεντ ποδιών υπ' άρ. 8 Kājiņu komplektācijas variants Nr. 8 Set complet de picioare nr. 8 Jalgade komplektsuse valik nr 8</p>		KF69	<p>Bed Leg h-120 / Pés para as camas h-120 / Pata para cama de h-120 / Bettfuß h-120 / Πόδιγια κρεβάτια h-120 / Gultas kājiņa h-120/ Picior pentru paturi h-120 / Voodi jalg h-120</p>	2
		KF37	<p>Decorative Nut / Anilha decorative / Tuerca decorative / Dekorative Mutter / Διακοσμητικό Πλυντήριο / Dekorativais Paplāksne / Piuliņā decoratīvā / Dekoratiivmutter</p>	2

Leg Parts No.9 Conjunto de pés №9 Modelo de pata nº 9 Komplettierung der Füße №9 Επιλογή για σετ ποδιών υπ' άρ. 9 Kājiņu komplektācijas variants Nr. 9 Set complet de picioare nr. 9 Jalgade kompleksuse valik nr 9		KF77	Bed Leg Chrome h-100 / Pés para as camas cromo h-100/ Pata para cama de cromo h-100/ Bettfuß Chrom h-100/ Πόδι για κρεβάτια χρώμο h-100 / Gultas kājiņa hroms h-100 / Picior pentru paturi crom h-100 / Voodi jalg kroom h-100	2
		KF39	Nut M8 DIN 936 / Tuerca M8 DIN 936 / Porca de parafuso M8 DIN 936 / Mutter M8 DIN 936 / Καρύδι M8 DIN 936 / Uzgrieznis M8 DIN 936 / Piuliņā M8 DIN 936 / Mutter M8 DIN 936	2
		KF40	Washer M8 / Porca M8 / Arandela M8 / Scheibe M8 / Πλυντήριο M8 / Paplāksne M8 / Šaibā M8 / Seib M8	2
Leg Parts No.10 Conjunto de pés №10 Modelo de pata nº 10 Komplettierung der Füße №10 Επιλογή για σετ ποδιών υπ' άρ. 10 Kājiņu komplektācijas variants Nr. 10 Set complet de picioare nr. 10 Jalgade kompleksuse valik nr 10		KF140	Decorative Support 60*60*195 M8 / Suporte decorativo 60*60*195 M8 / Soporte decorative de 60*60*195 M8 / Dekorative Stiitze 60*60*195 M8 / Διακοσμητικό στήριγμα 60*60*195 M8/ Dekoratīvs balsts 60*60*195 M8 / Suport decorativ 60*60*195 M8 / Dekoratiivne tugi 60*60*195 M8	2
		KF39	Nut M8 DIN 934 / Tuerca M8 DIN 934 / Porca de parafuso M8 DIN 934 / Mutter M8 DIN 934 / Καρύδι M8 DIN 934 / Uzgrieznis M8 DIN 934 / Piuliņā M8 DIN 934 / Mutter M8 DIN 934	2
		KF40	Washer M8 / Porca M8 / Arandela M8 / Scheibe M8 / Πλυντήριο M8 / Paplāksne M8 / Šaibā M8 / Seib M8	2
		KF81	Felt Damper 20*20 / Amortecedor de feltro 20*20 / Fielthro protector 20*20 / Filziger Dampfer 20*20 / Αποσβεστήρας από τσόχα 20*20 / Filca amortizators 20*20 / Amortizor din pāslā 20*20 / Vildist amortisaator 20*20	2
Leg Parts No.11 Conjunto de pés №11 Modelo de pata nº 11 Komplettierung der Füße №11 Επιλογή για σετ ποδιών υπ' άρ. 11 Kājiņu komplektācijas variants Nr. 11 Set complet de picioare nr. 11 Jalgade kompleksuse valik nr 11		KF141	Bed Leg h-120 / Pés para as camas h-120 / Pata para cama de h-120 / Bettfuß h-120 / Πόδι για κρεβάτια h-120 / Gultas kājiņa h-120 / Picior pentru paturi h-120 / Voodi jalg h-120	2
		KF39	Nut M8 DIN 934 / Tuerca M8 DIN 934 / Porca de parafuso M8 DIN 934 / Mutter M8 DIN 934 / Καρύδι M8 DIN 934 / Uzgrieznis M8 DIN 934 / Piuliņā M8 DIN 934 / Mutter M8 DIN 934	2
		KF40	Washer M8 / Porca M8 / Arandela M8 / Scheibe M8 / Πλυντήριο M8 / Paplāksne M8 / Šaibā M8 / Seib M8	2
Leg Parts No.12 Conjunto de pés №12 Modelo de pata nº 12 Komplettierung der Füße №12 Επιλογή για σετ ποδιών υπ' άρ. 12 Kājiņu komplektācijas variants Nr. 12 Set complet de picioare nr. 12 Jalgade kompleksuse valik nr 12		KF130	Decorative Support 60*45*120 M8 / Suporte decorativo 60*45*120 M8 / Soporte decorative de 60*45*120 M8/ Dekorative Stiitze 60*45*120 M8/ Διακοσμητικό στήριγμα 60*45*120 M8/ Dekoratīvs balsts 60*45*120 M8/ Suport decorativ 60*45*120 M8/ Dekoratiivne tugi 60*45*120 M8	2
		KF39	Nut M8 DIN 934 / Tuerca M8 DIN 934 / Porca de parafuso M8 DIN 934 / Mutter M8 DIN 934 / Καρύδι M8 DIN 934 / Uzgrieznis M8 DIN 934 / Piuliņā M8 DIN 934 / Mutter M8 DIN 934	2
		KF40	Washer M8 / Porca M8 / Arandela M8 / Scheibe M8 / Πλυντήριο M8 / Paplāksne M8 / Šaibā M8 / Seib M8	2
		KF81	Felt Damper 20*20 / Amortecedor de feltro 20*20 / Fielthro protector 20*20 / Filziger Dampfer 20*20 / Αποσβεστήρας από τσόχα 20*20/ Filca amortizators 20*20 / Amortizor din pāslā 20*20 / Vildist amortisaator 20*20	2

Before Assembly:

1. Check the appearance and completeness of items in pack! Claims for damage can only be made for articles with NO evidence of assembly.
2. Keep packs and instructions until assembly completed! If defects or missing parts are noted during assembly, the pack must be kept until the arrival of Seller's representative.
3. Check the quantity of hardware items against the list. The manufacturer retains the right to make construction changes in an item, replace hardware and fasteners with equivalent items that do not detract from their appearance, nor affect their functionality. In the case of missing parts or breakage, circle the number of the missing item and inform the store to receive a replacement.
4. Follow the assembly sequence in these instructions! Manufacturer's warranty obligations become void if instructions for assembly and use are not followed.
5. Install the bed on a level floor surface! On an uneven floor, the bed adjustment mechanisms may not work correctly or become deformed. Assemble bed with 2 people.
6. Assemble parts with care without sharp twists. Set parts stably on floor. Avoid dropping or banging!
7. Move furniture and its parts with only slight lifting. This helps to prevent distortions and breakage.
8. Be sure to lubricate the lifting mechanism during assembly according to the instructions! It allows you to avoid early appearance of creaking. Repeat lubrication; tighten loose bolts and nuts at least once every six months
9. New furniture can give off the original smell of the materials from which it is manufactured. The smell can last for three weeks after assembly. It is recommended to vacuum an item and ventilate the room to reduce the strength of the smell. One should repeat these steps 3-4 times per day.

Antes del montaje:

1. ¡Compruebe el aspecto y la integridad de las piezas en el embalaje! Se aceptan reclamaciones por daños solo de los artículos SIN rastros de montaje.
2. ¡Conserve el embalaje y las instrucciones hasta terminar el montaje! Si durante el proceso de montaje se detecta algún defecto y falta de alguna pieza del artículo, debe conservar el embalaje hasta la llegada a su domicilio del representante de la empresa comercial.
3. Verifique la cantidad de accesorios según la lista. El fabricante se reserva el derecho de realizar cambios estructurales del artículo, reemplazar accesorios y piezas metálicas por otros similares que no afecten la apariencia y las propiedades funcionales del artículo. En caso de falta o rotura, marque el número de la pieza faltante e informe a la tienda para su cambio.
4. ¡Siga el procedimiento de montaje que se proporciona en este manual! Si no se sigue las instrucciones de montaje y uso, el fabricante no se responsabiliza de la garantía.
5. Para el montaje de la cama, ¡elijá una superficie plana! En una superficie no plana, es posible el mal funcionamiento del mecanismo de transformación de la cama, deformaciones del artículo.
6. El montaje de la cama debe ser realizada por dos personas. Mueva todas las piezas con cuidado, sin sacudidas, colóquelas sólidamente, evite las caídas y golpes!
7. Mueva el mueble y sus piezas levantando ligeramente. Esto permitirá evitar la deformación y roturas.
8. ¡Lubrique sin falta el mecanismo de elevación durante el ensamble, de acuerdo con las instrucciones! Esto evitará que surjan crujidos antes de tiempo. Repita le lubricación y apriete los tornillos y tuercas flojas al menos una vez cada seis meses.
9. El mueble nuevo puede emitir un olor natural de los materiales de fabricación. El olor puede persistir hasta por tres semanas desde el momento del montaje. Para reducir la intensidad del olor, se recomienda aspirar el artículo y ventilar la habitación. Estas acciones deben repetirse 3-4 veces al día.

Antes da montagem:

1. Verifique o tipo e a integridade das peças da embalagem! Reclamação somente por defeitos de fabricação SEM vestígios de montagem.
2. Guarde a embalagem e o manual antes de terminar a montagem! Se identificar que produto está com defeito e incompleto durante a montagem, é necessário guardar a embalagem até a visita do representante comercial da empresa.
3. Verifique o número de peças de acessórios de acordo com a lista. O fabricante reserva-se o direito de fazer alterações estruturais no produto, substituir acessórios e peças por similares que não prejudiquem a aparência e não afetem as propriedades funcionais do produto. Em caso de falta ou dano, destaque o número da peça que falta e informe à loja para que seja feita a substituição.
4. Observe a sequência de montagem que está nas instruções! A não observância das instruções de montagem e de operação do fabricante retira as obrigações de garantia.
5. Escolha uma área plana para a instalação da cama! Com a curvatura do piso, podem ocorrer desvios na operação do mecanismo de transformação da cama, o que pode distorcer a forma do produto.
6. Não realize a montagem da cama sozinho(a). Mova todas as peças com cuidado, sem solavancos, coloque-as firmemente, evite quedas e batidas!
7. Para mover o móvel e suas peças, apenas levante-o um pouco. Isto evitará deformação e quebra.
8. De acordo com o manual na montagem precisa lubrificar um mecanismo de elevação necessariamente. Isso permitirá evitar o aparecimento de ruídos prematuros. Repita a lubrificação, aperte os parafusos e as porcas soltos pelo menos.
9. Móveis novos podem exalar o cheiro natural dos materiais dos quais são feitos. O cheiro pode persistir por três semanas após a montagem. Para reduzir a intensidade do cheiro, é recomendável aspirar o produto e ventilar a área. Isto deve ser feito 3-4 vezes ao dia.

Vor der Montage:

1. Überprüfen Sie bitte das Aussehen und die Vollständigkeit der Bauelemente in der Verpackung! Reklamationen wegen einer Beschädigung der Bauelemente werden nur bei Produkten OHNE Montagespuren angenommen.
2. Bewahren Sie bitte die Verpackung und die Montierungsanweisungen bis Ende der Montage auf! Bei der Feststellung von Mangelwaren im Prozess der Montage und einer Unvollständigkeit des Produktes muss man die Verpackung bis zum Moment aufbewahren, wenn ein Vertreter des Handelsunternehmens zu Ihnen kommt.
3. Überprüfen Sie die Anzahl der Bauelemente und der Beschläge laut der Liste. Das Herstellerunternehmen behält sich das Recht vor, konstruktive Änderungen im Produkt einzutragen, Beschläge und Kleinteile gegen gleiche Elemente zu ersetzen, die das Aussehen nicht verschlechtern und die Funktionseigenschaften des Produktes nicht beeinflussen. Im Fall einer Unvollständigkeit oder eines Defektes,

zeichnen Sie bitte die Nummer des abwesenden Bauelementes aus und teilen Sie davon dem Lieferanten für seinen Ersatz mit.

- Halten Sie bitte die Ordnung der Montage ein, die in dieser Bedienungsanleitung angegeben ist! Wenn die Montierungsanweisungen und Bedienungsanweisungen nicht eingehalten werden, erlöschen die Garantieverpflichtungen des Herstellerunternehmens.
- Wählen Sie eine flache Bodenfläche für die Montage des Bettes! Wenn Verformungen des Bodens vorliegen, sind Abweichungen in der Arbeit des Transformationsmechanismus des Bettes und Schiefstellungen der Form des Produktes möglich.
- Führen Sie die Montage des Bettes zu zweit aus. Bewegen Sie alle Bauelemente vorsichtig, ruckfrei, legen Sie sie bitte trittsicher, vermeiden Sie, dass sie fallen und geschlagen werden!
- Bewegen Sie das Möbel und seine Bauelemente nur wenig lüpfend. Das lässt Verformungen und Brüche vermeiden.
- Schmieren Sie die reibenden Teile der Vorrichtung während der Montage, schrauben Sie gelöste Bolzen und Muttern nicht seltener als einmal im halben Jahr! Das lässt die Entstehung des frühzeitigen Knirschens vermeiden.
- Das neue Möbel kann einen natürlichen Duft der Stoffe haben, wovon es hergestellt ist. Der Duft kann im Laufe von drei Wochen ab dem Moment der Montage bleiben. Es wird empfohlen, das Produkt mit dem Staubsauger zu reinigen und den Raum zu lüften, damit die Intensität des Duftes reduziert wird. Diese Handlungen muss man 3-4 Mal pro Tag ausführen.

Πριν από τη συναρμολόγηση:

- Ελέγξτε την εμφάνιση και την ακεραιότητα των ανταλλακτικών στη συσκευασία! Αξιώσεις για ζημιά μόνο σε προϊόντα ΧΩΡΙΣ ίχνη συναρμολόγησης.
- Διατηρήστε τη συσκευασία και τις οδηγίες μέχρι το τέλος της συναρμολόγησης! Εάν κατά τη διαδικασία συναρμολόγησης εντοπιστεί ελαττωματικό και ελλιπές προϊόν, είναι απαραίτητο να διατηρήσετε τη συσκευασία μέχρι να έρθει εκπρόσωπος της εμπορικής εταιρείας σε σας.
- Ελέγξτε τον αριθμό των εξαρτημάτων υλικού σύμφωνα με τη λίστα. Ο κατασκευαστής διατηρεί το δικαίωμα να κάνει αλλαγές στο σχεδιασμό του προϊόντος, να αντικαταστήσει εξαρτήματα και εξοπλισμό με παρόμοια που δεν επιδεινώνουν την εμφάνιση και δεν επηρεάζουν τις λειτουργικές ιδιότητες του προϊόντος. Σε περίπτωση ατελούς ή βλάβης, κάντε κύκλο στον αριθμό του ελλείποντος τμήματος και ενημερώστε το κατάστημα για την αντικατάστασή του.
- Ακολουθήστε τη σειρά συναρμολόγησης που παρέχεται σε αυτό το εγχειρίδιο! Η μη τήρηση των οδηγιών συναρμολόγησης και λειτουργίας ακυρώνει την εγγύησή του κατασκευαστή.
- Για να εγκαταστήσετε το κρεβάτι, επιλέξτε μια επίπεδη επιφάνεια του δαπέδου! Με καμπυλότητες δαπέδου, είναι πιθανές αποκλίσεις στη λειτουργία του μηχανισμού μετασχηματισμού κλίνης και παραμορφώσεων σχήματος προϊόντος. Συναρμολογήστε το κρεβάτι μαζί.
- Μετακινήστε προσεκτικά όλα τα υλικά, χωρίς να χτυπήσετε, τοποθετήστε τα με ασφάλεια, αποφύγετε την πτώση και την πρόσκρουση!
- Μετακινήστε τα έπιπλα και τα μέρη του λίγο ανεβαινόντας τα. Αυτό θα εξαλείψει τις παραμορφώσεις και τις βλάβες. Φροντίστε να λιπάνετε το μηχανισμό ανύψωσης κατά τη συναρμολόγηση σύμφωνα με τις οδηγίες! Αυτό θα αποφύγει το πρόωρο τσίμπημα.
- Φροντίστε να λιπάνετε το μηχανισμό ανύψωσης κατά τη συναρμολόγηση σύμφωνα με τις οδηγίες! Αυτό θα αποφύγει το πρόωρο τσίμπημα. Λιπάνετε εκ νέου, σφίξτε τα χαλαρά μπουλόνια και τα παξιμάδια τουλάχιστον μία φορά κάθε έξι μήνες.
- Τα νέα έπιπλα μπορεί να εκπέμπουν μια φυσική μυρωδιά υλικών από τα οποία είναι κατασκευασμένα. Η μυρωδιά μπορεί να διαρκέσει έως και τρεις εβδομάδες από την ημερομηνία συναρμολόγησης. Για να μειώσετε την ένταση της οσμής, συνιστάται να καθαρίσετε με ηλεκτρική σκούπα το προϊόν και να αερίσετε το δωμάτιο. Αυτά τα βήματα πρέπει να επαναλαμβάνονται 3-4 φορές την ημέρα.

Pirms montāžas darbiem:

- Pārbaudiet detaļu izskatu un pilnību iepakojumā! Prasības par to bojājumiem tikai produktiem BEZ montāžas darbu pēdām.
- Saglabājiet iepakojumu un instrukciju līdz montāžas darbu beigām! Ja montāžas procesā tiek atklāts produkta defekts un nepilnība, Jums ir jā saglabā iesaiņojums, līdz tirdzniecības uzņēmuma pārstāvis atbrauks pie Jums.
- Pārbaudiet piederumu skaitu atbilstoši sarakstam. Ražotājs patur tiesības veikt izstrādājuma konstruktīvās izmaiņas, nomainīt piederumus un metālizstrādājumus ar analogiem, kuri nepasliktina izskatu un neietekmē produkta funkcionālās īpašības. Nepilnības vai bojājumu gadījumā apvelciet trūkstošās daļas numuru un informējiet veikalā par tās nomaiņu.
- Izpildiet šajā instrukcijā norādīto montāžas kārtību! Montāžas un lietošanas instrukcijas neievērošana anulē ražotāja garantijas atbildību.
- Lai uzstādītu gultu, izvēlieties līdzenu grīdas virsmu! Pie grīdas izliekumiem ir iespējamas novirzes gultas pārveidošanas mehānisma darbībā, izstrādājuma formas deformācijas. Gultas montāžas darbus veiciet divatā.
- Pārvietojiet visas daļas uzmanīgi, bez raustīšanās, novietojiet tās droši, izvairieties no viņu krišanas un triecieniem! Pārvietojiet mēbeles un to daļas, tikai nedaudz paceļot. Tas novērsīs deformācijas un lūzumus.
- Montāžas laikā noteikti ieeļļojiet pacēlāja mehānismu saskaņā ar instrukcijām! Tas ļaus izvairīties no priekšlaicīgas čīkstēšanas. Atkārtoti ieeļļojiet, pievelciet vaļīgas skrūves un uzgriežņus vismaz reizi sešos mēnešos.
- Montāžas laikā noteikti ieeļļojiet pacēlāja mehānismu saskaņā ar instrukcijām! Tas ļaus izvairīties no priekšlaicīgas čīkstēšanas. Atkārtoti ieeļļojiet, pievelciet vaļīgas skrūves un uzgriežņus vismaz reizi sešos mēnešos.
- Jaunas mēbeles var izdalīt dabisku smaržu no materiāliem, no kuriem tās izgatavotas. Smarža var ilgt līdz trim nedēļām no montāžas datuma. Lai samazinātu smakas intensitāti, ieteicams produktu nosūkt ar putekļu sūcēju un izvēdināt telpu. Šīs darbības jāatkārto 3-4 reizes dienā.

Înainte de asamblare:

- Verificați aspectul și integritatea detaliilor din pachet! Cererile pentru daunele lor sunt acceptate numai pentru produse FĂRĂ urme de asamblare.
- Păstrați ambalajul și instrucțiunile până la sfârșitul asamblării! La detectarea defectelor în procesul de asamblare și dacă produsul este incomplet, este necesar să păstrați ambalajul până când reprezentantul companiei comerciale vă vizitează.
- Verificați numărul de detalii și accesorii conform listei. Producătorul își rezervă dreptul de a face modificări constructive ale produsului, de a înlocui fittingurile și hardware-ul cu altele similare, care nu degradează aspectul și nu afectează proprietățile funcționale ale produsului. Dacă există o lipsă sau o defecțiune, încercați numărul detalii lipsă și informați magazinul să o înlocuiască.
- Urmați procedura de asamblare dată în această instrucțiune! În caz de nerespectare a instrucțiunilor de asamblare și utilizare, obligațiile de garanție de la producător sunt eliminate.

5. Pentru a instala patul, alegeți o zonă plată a podelei! În cazul curbării podelei, abaterile sunt posibile în funcționarea mecanismului de transformare a patului și distorsiuni ale formei produsului.
6. Se recomandă ca două persoane să efectueze asamblarea patului. Mutați cu atenție toate detaliile, fără smucituri, le puneți stabil, evitați căderi și lovituri lor!
7. Mutați mobilierul și detaliile acestuia, ridicând doar ușor. Aceasta va elimina deformările și defalcări.
8. Asigurați-vă că lubrifiați mecanismul de ridicare în timpul asamblării, conform instrucțiunilor! Aceasta va ajuta la evitarea apariției scârâitului prematur. Repetați lubrifierea, strângeți șuruburile și piulițele slăbite cel puțin o dată la șase luni.
9. Mobilierul nou poate avea un miros natural al materialelor din care este fabricat. Mirosul poate persista timp de trei săptămâni de la momentul asamblării. Pentru a reduce intensitatea mirosului, se recomandă aerisirea produsului și ventilarea camerei. Aceste acțiuni trebuie repetate de 3-4 ori pe zi.

Enne kokkupanemist:

1. Kontrollige pakendis olevate detailide välimust ja tervikkikkust! Nende kahjuga seotud pretensioone aktsepteeritakse ainult ILMA kokkupanemisjälgedeta toodete puhul.
2. Säilitage pakend ja juhised kuni kokkupaneku lõpuni! Diivani kokkupanemisel toote praagi ja mittekomplektsuse tuvastamisel pakend on vajalik säilitada kuni kaubandusettevõtte esindaja teie juurde tulekuni.
3. Kontrollige detailide ja furnituuri arvu vastavalt loendile. Tootja jätab endale õiguse teha tootes konstruktsioonilisi muudatusi, vahetada furnituur ja peenraud sarnaste vastu, mis ei halvenda välimust ega mõjuta toote funktsionaalseid omadusi. Puuduse või rikke korral, märgistage puuduva detaili number ümber ja võtke asendamiseks ühendust kauplusega.
4. Järgige selles juhendis antud kokkupanemise järjestust! Kokkupanemis- ja kasutusjuhendi mittejärgimisel, kaotab tootja garantii kehtivuse.
5. Diivani paigaldamiseks valige tasane põrandapind! Põranda kumerusel võib esineda kõrvalekaldeid diivanvoodi/tugitoolvoodi transformatsiooni mehhanismi töös, toote kuju moonutusi.
6. Pange diivan kokku kahekesi. Liigutage kõiki detaile ettevaatlikult, ilma tõmblusteta, asetage need kindlalt, vältige nende kukkumist ja löömist!
7. Liigutage mööblit ja selle detaile, tõstes vaid veidi. See hoiab ära deformatsiooni ja purunemise.
8. Määrige kindlasti tõstemehhanismi kokkupanemise ajal vastavalt juhendile! See hoiab ära enneaegse krigisemise. Korrake määrimist, pingutage silmnähtavalt lahtised poldid ja mutrid vähemalt kord kuue kuu tagant.
9. Uus mööbel võib materjalidest, millest see on valmistatud, eraldada loomulikku lõhna. Lõhn võib püsida kolme nädala jooksul alates kokkupaneku hetkest. Lõhna intensiivsuse vähendamiseks on soovitatav toode tolmuimejaga imeda ja ruumi tuulutada. Neid toiminguid tuleb korrata 3-4 korda päevas.

Items required for assembly is listed below/ Para el ensamble usted necesitará/ Para montagem, você precisará/ Für die Montage brauchen Sie Folgendes/ Για την συναρμολόγηση θα χρειάζεστε/ Montāžas darbiem nepieciešams/ Pentru asamblarea veți avea nevoie de/ Kokkupanemiseks vajate:

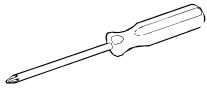
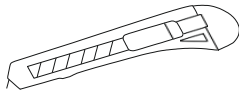
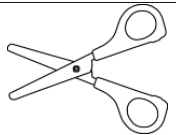
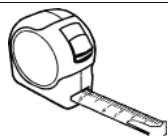
	<p>Phillips Screwdriver Chave de fenda estrela / Destomillador de estrella Kreuzschraubenzieh / Κατσαβίδι εγκάρσιας κεφαλής Skrüvgriezis krusta / Şurubelnişă cu cap Ristpeaga kruvikeeraja</p>
	<p>Boxcutter Estilete / Cuchillo de papelería Büromesser / Μαχαίρι / χαρτικών/ Kancelejas Nazis / Cuşit de papetărie Kirjatarvete nuga</p>
	<p>Scissors Tijeras / Tesoura Schere / Ψαλίδια/ Şķēres / Foarfece / Käärid</p>
	<p>Tape Measure Fita métrica Cinta métrica / Messband Ρουλέτα / Rulete Ruletā / Mõõdulint</p>

1)

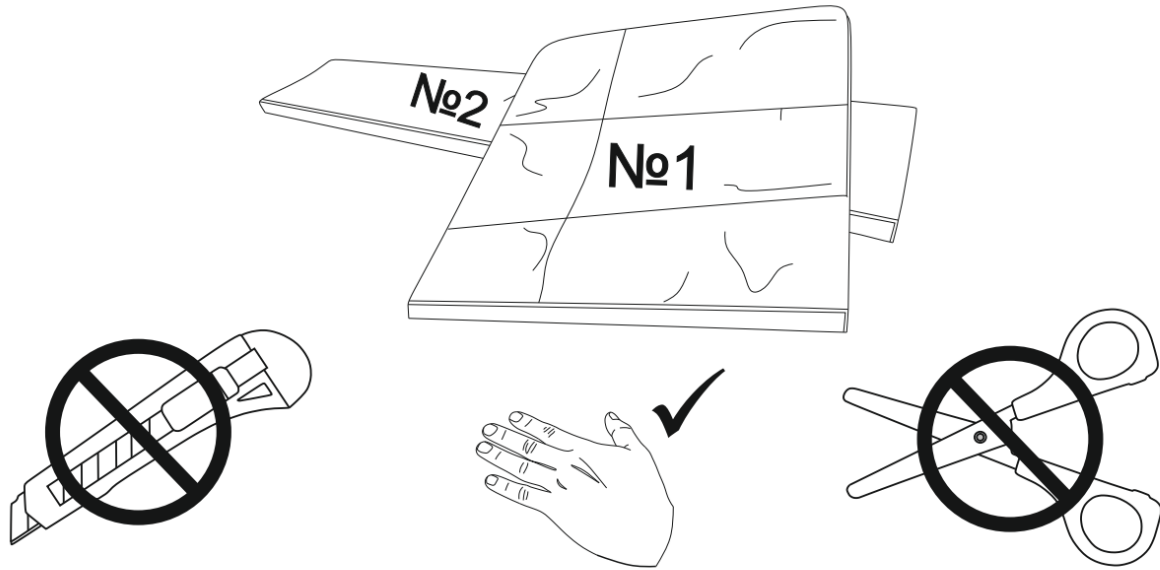

2)

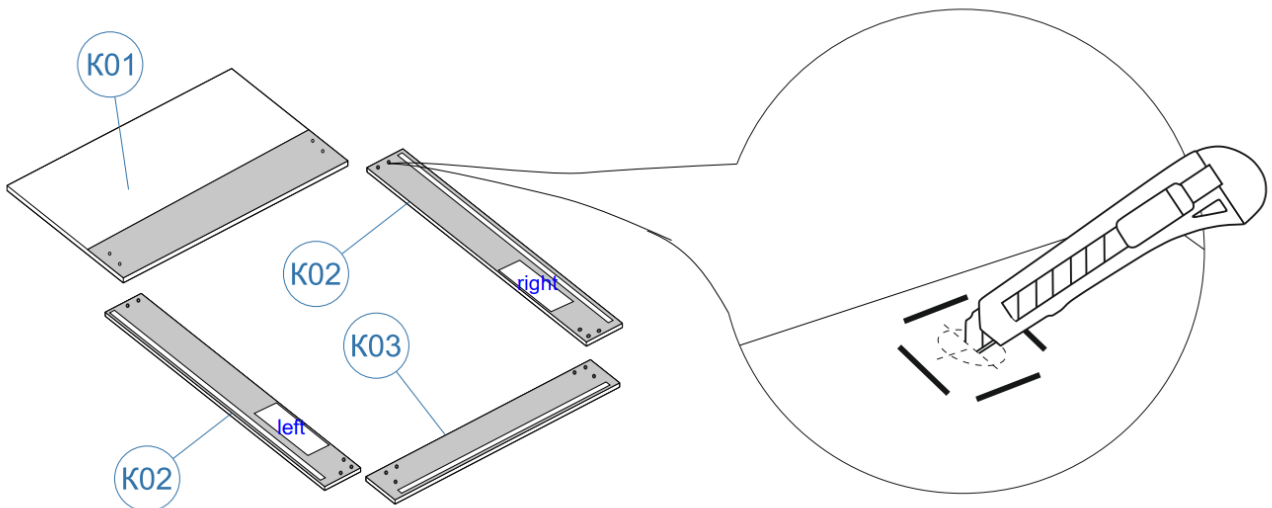

3)

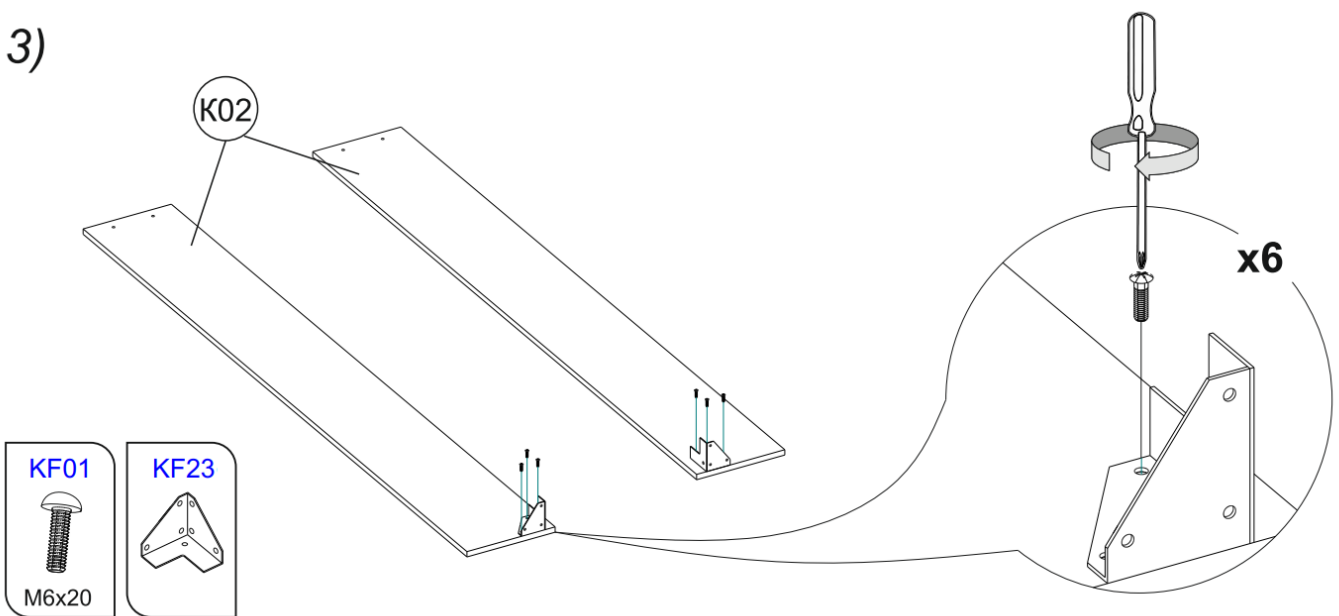

4)

Leg Parts No.1

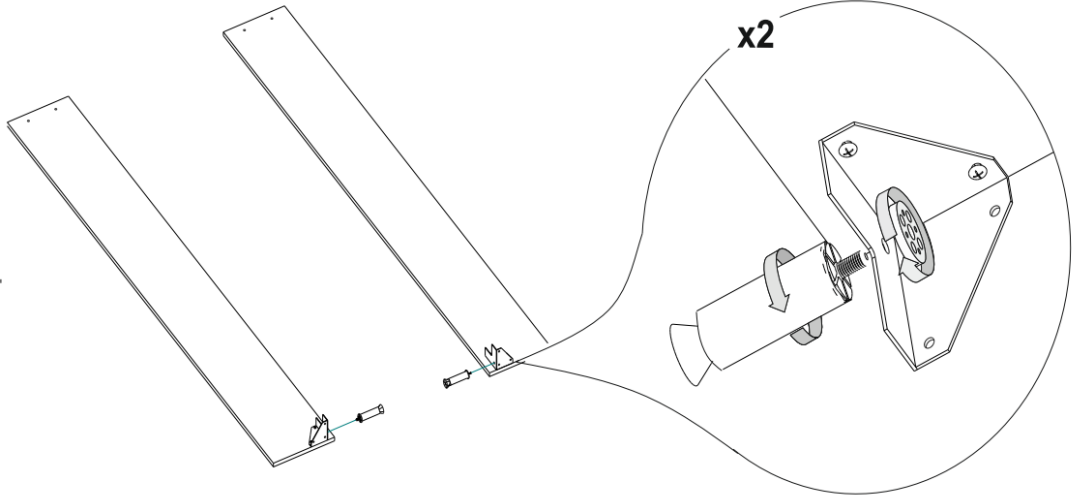
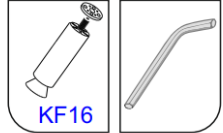
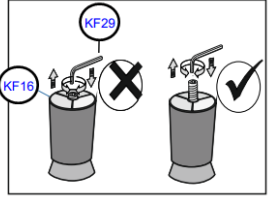

5)

Leg Parts No.2

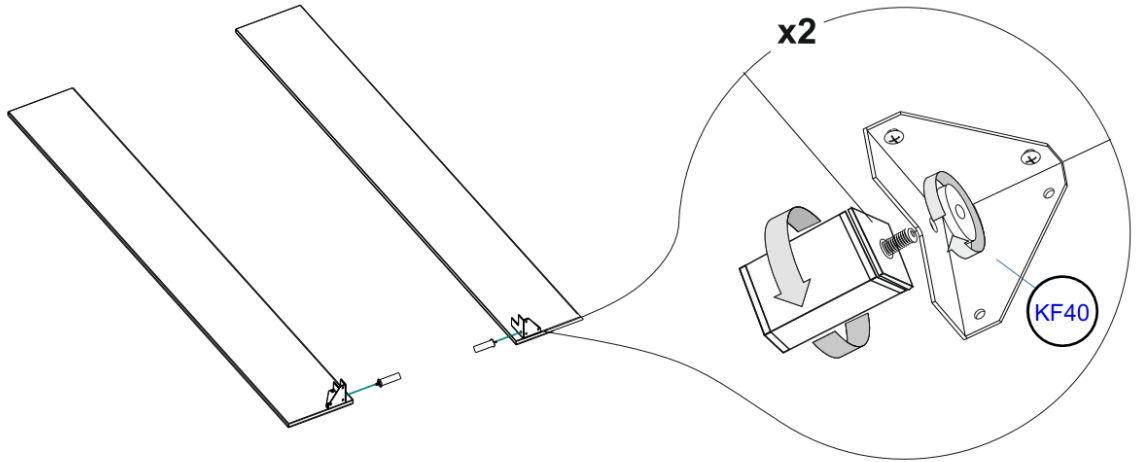
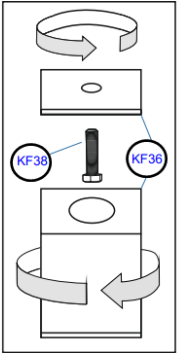

6)

Leg Parts No.3

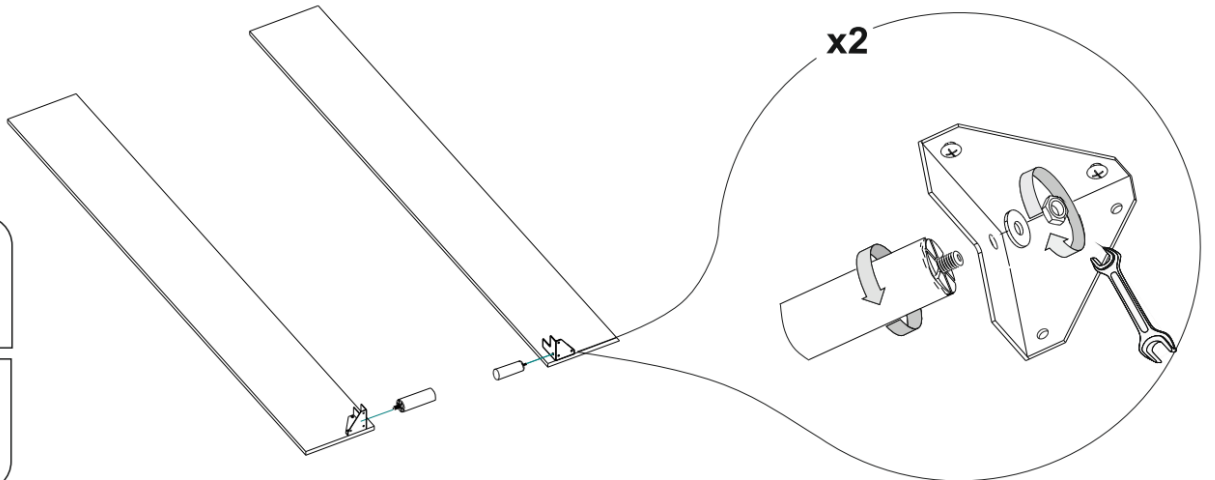
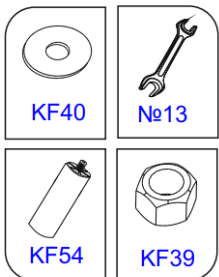

7)

Leg Parts No.4

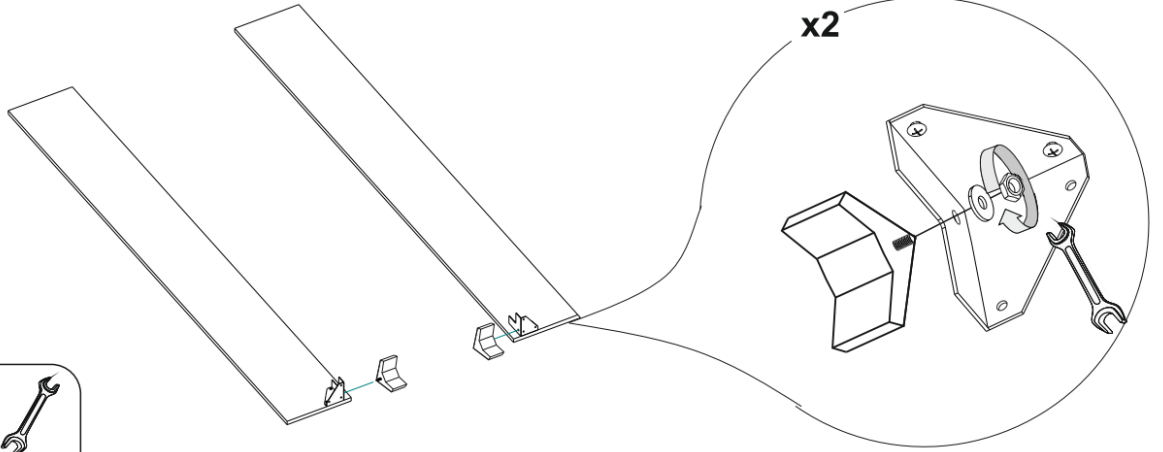
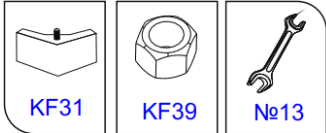
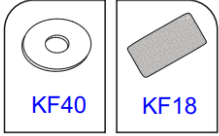
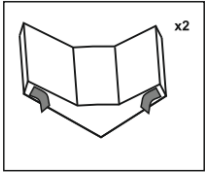

8)

Leg Parts No.5

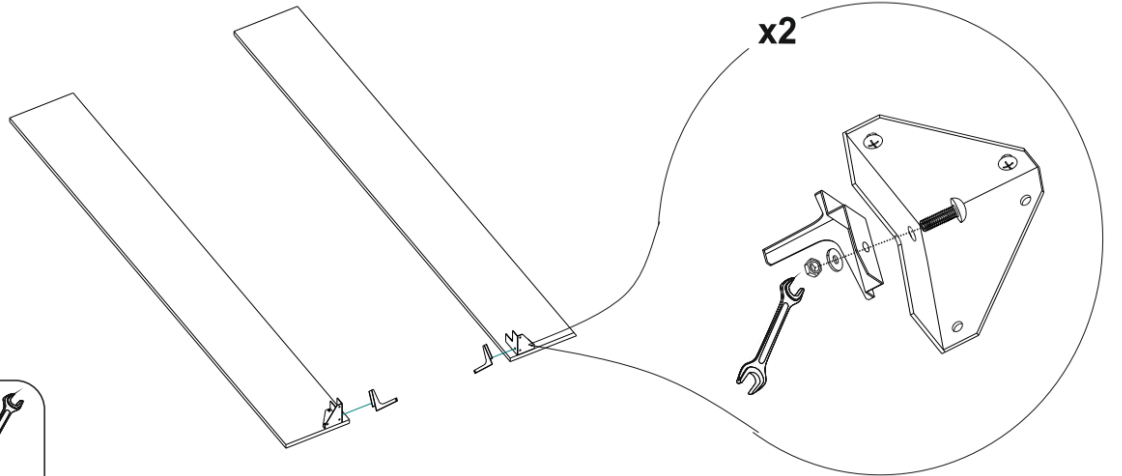
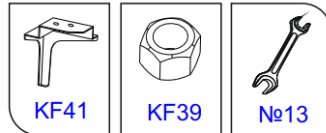
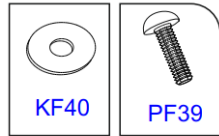
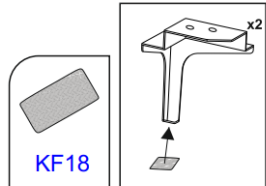

9)

Leg Parts No.6

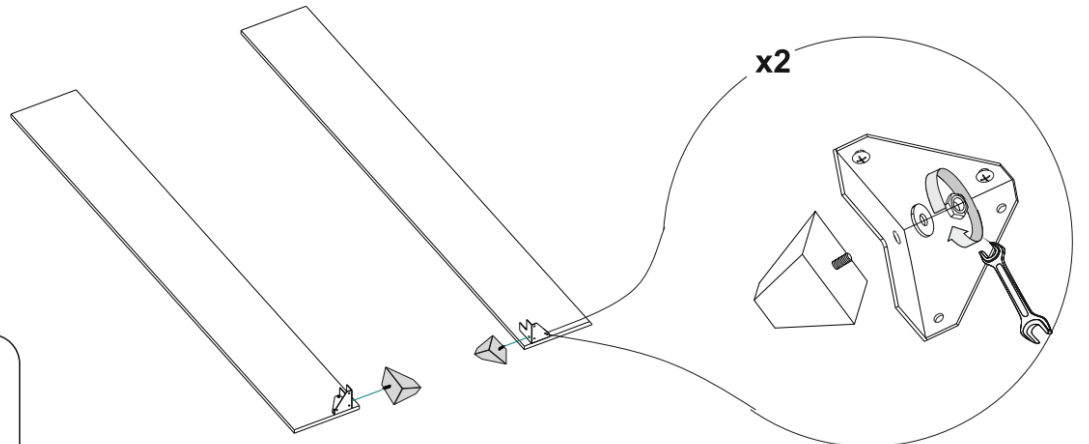
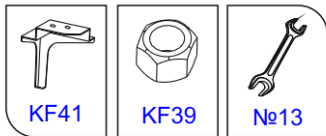
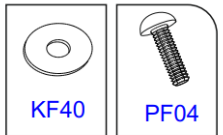
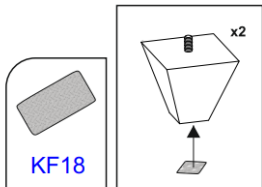

10)

Leg Parts No.7

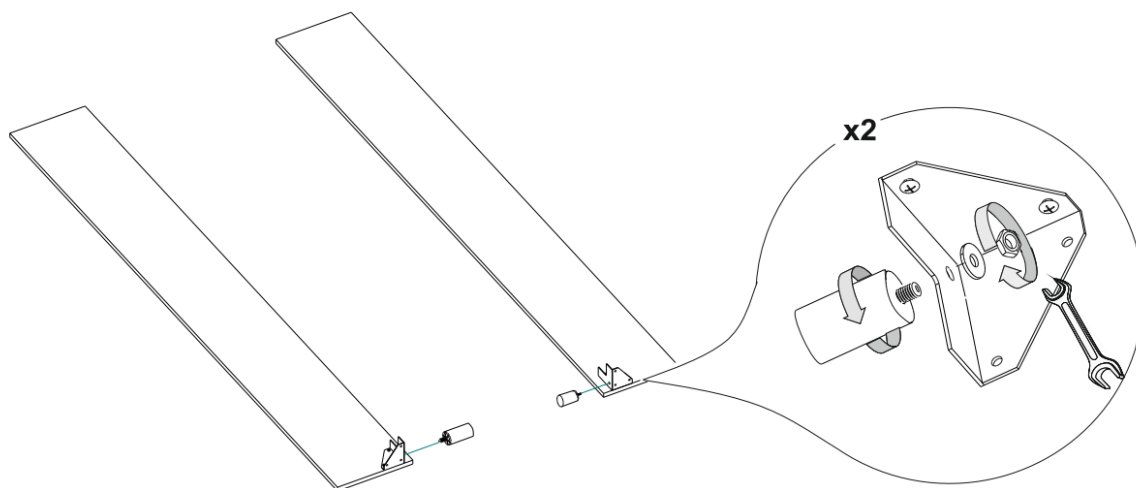

11)

Leg Parts No.8

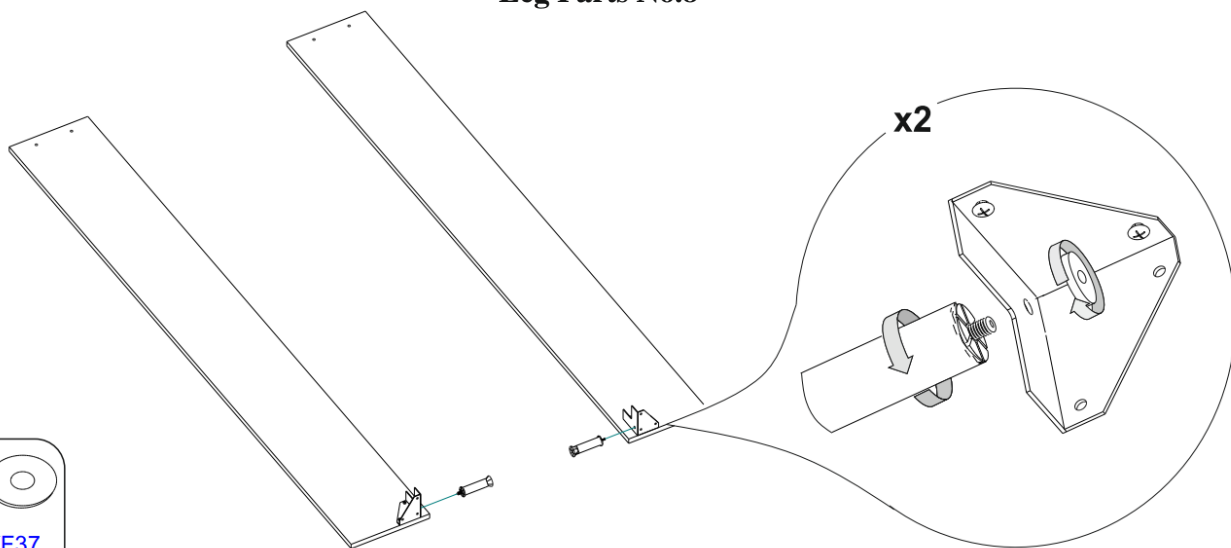
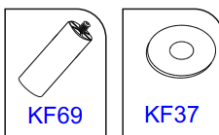

12)

Leg Parts No.9

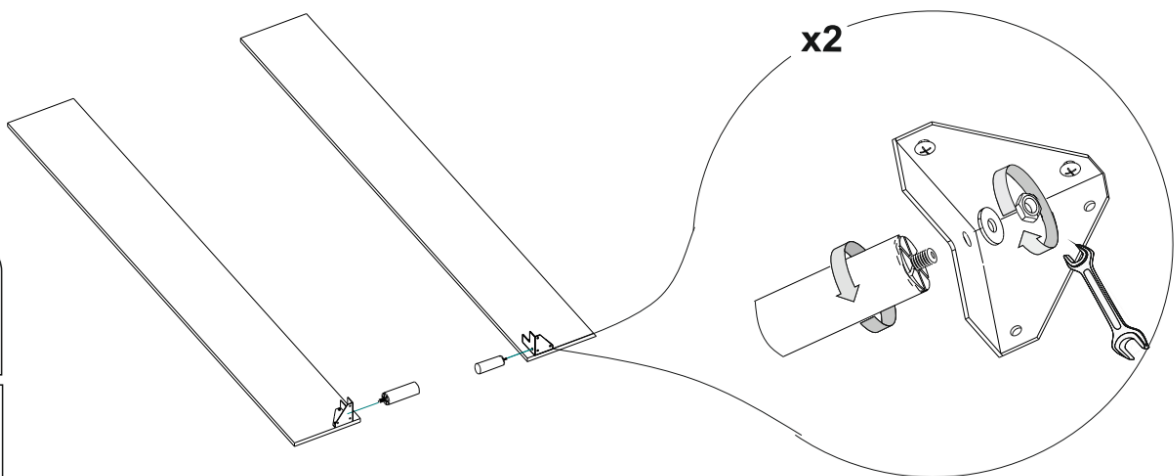

13)

Leg Parts No.10

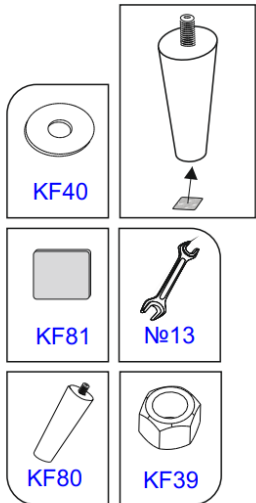

14)

Leg Parts No.11



15)

Leg Parts No.12

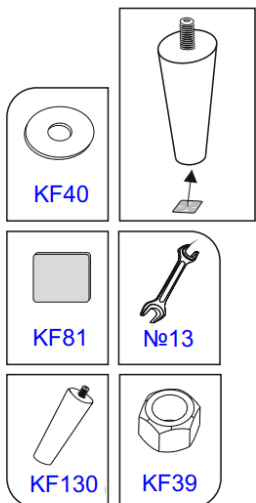

16)

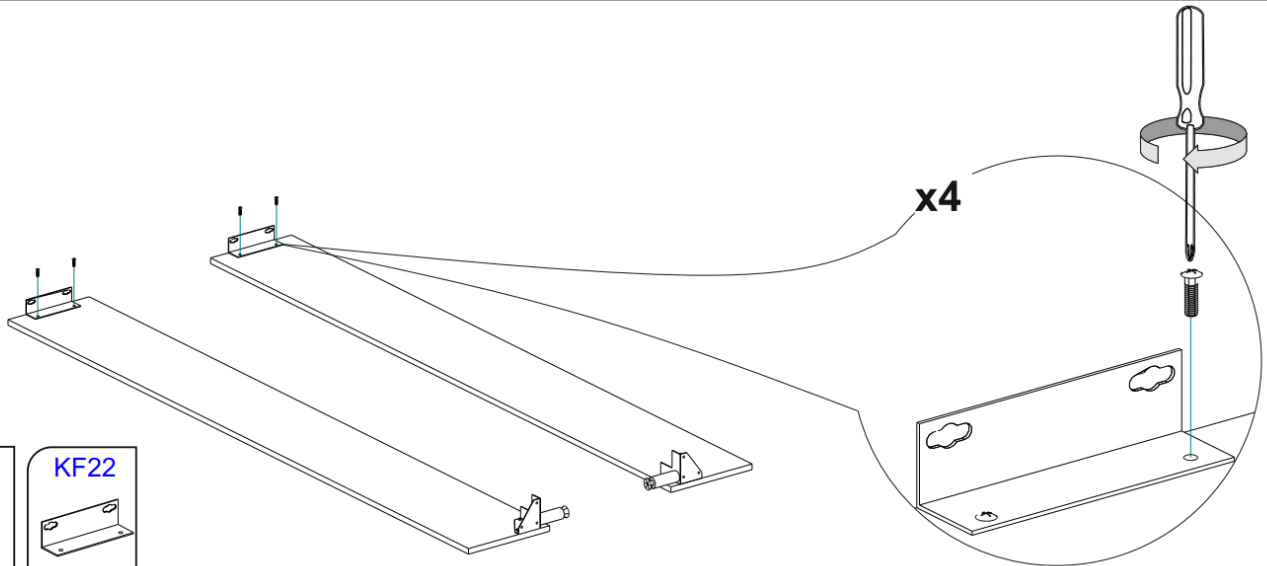
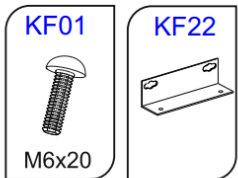

17)

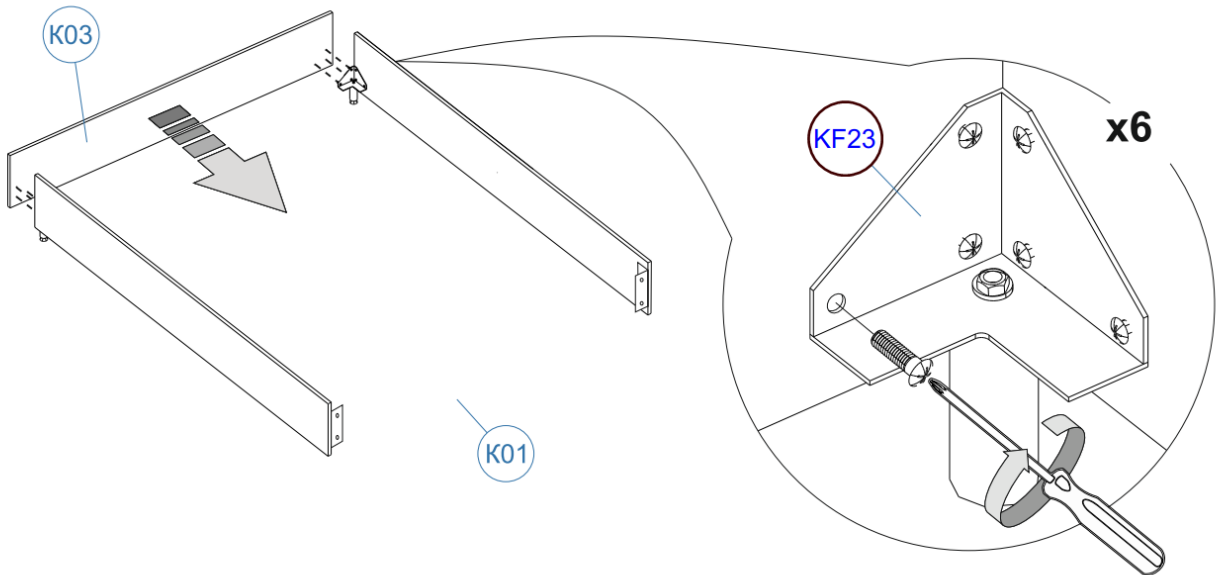

18)

Installing the cover on the side-bars before attaching the headboard is only for beds Naomi, Emma, Rosalie, Merelin Premier

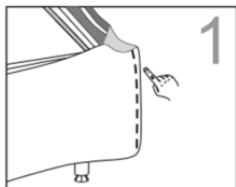

1
Align the seams of the cover with the corners of the side-bars

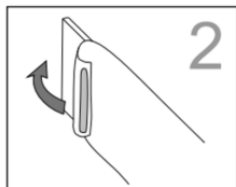

2
Fasten the ends of the cover

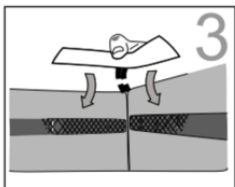

3
Fasten the upper end of the cover on the corners



4
Spread the cover evenly on the side-bars

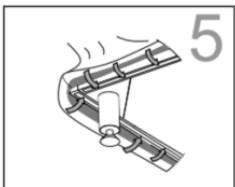

5
Fasten the lower end of the cover

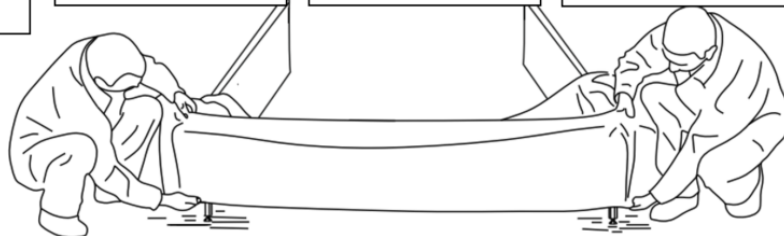

Do not unscrew the edge row of screws (if applicable)!
 Não desaperte os parafusos da fila exterior (se existirem)!
 ¡No desatornille los tornillos de la fila exterior (si los hay)!
 Die äußere Reihe der Schrauben nicht ausschrauben (wenn sie vorhanden sind)!
 Μην ξεβιδώσετε την εξωτερική γραμμή βιδών (εάν υπάρχει)!
 Neskrūvējiet ārējo skrūvju rindu (ja tāda ir)!
 Nu deșurubați rândul exterior al șuruburilor (dacă există)!
 Ärge keerake lahti viimast kruvide rida (kui on olemas)!

19)

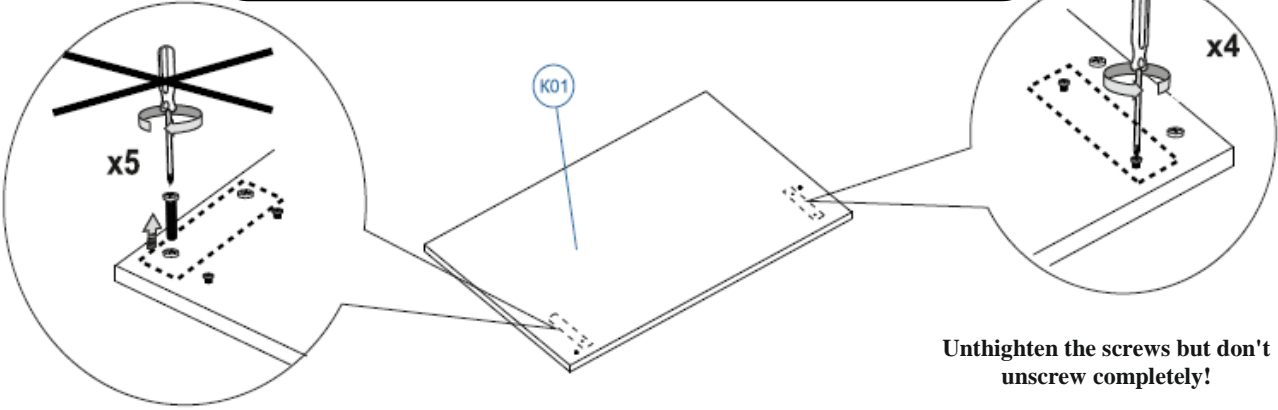

20)

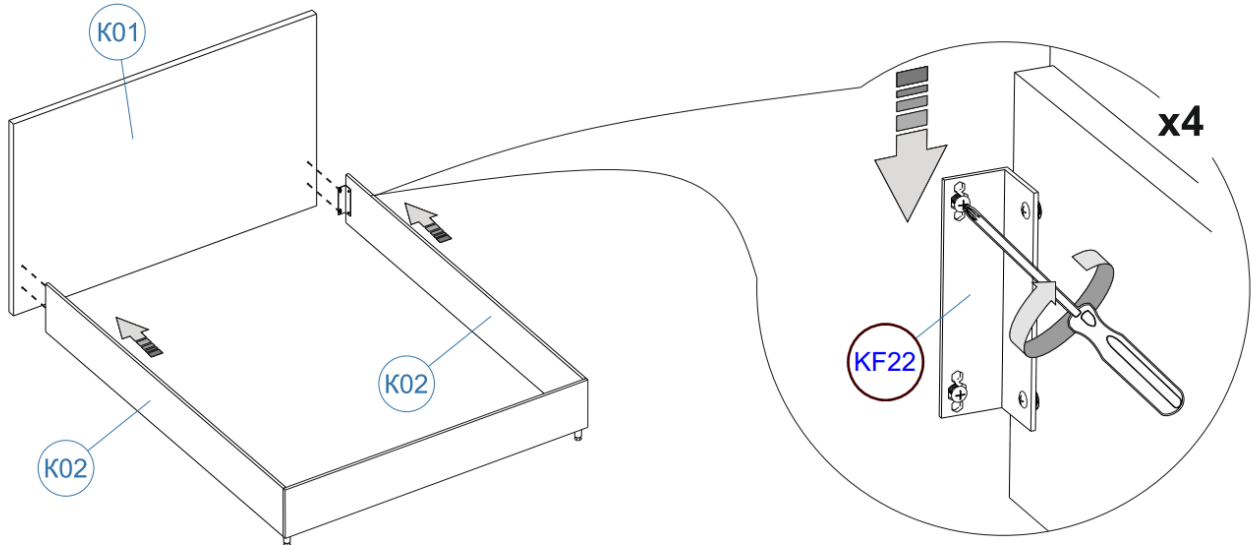

21)

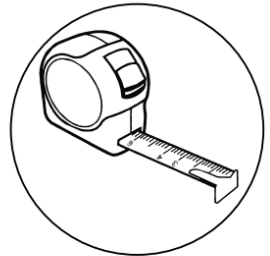
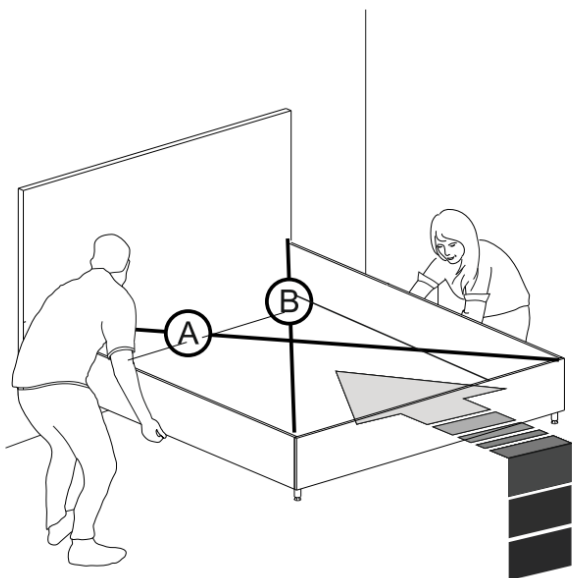

A ≈ B ^{OK}

This step refers only to beds with a removable case and rails fully upholstered with technical fabric!

Isto é apenas para as camas com uma capa removível e barras totalmente estofadas em tecido técnico!

¡Solo para camas con funda extraíble y bastidores completamente tapizados con lona de algodón!

Nur für Betten mit entfernbarem Bezug und Zargen, die völlig mit Padding bezogen sind!

Αυτό ισχύει μόνο για κρεβάτια με αφαιρούμενα κάλυμματα και σράγια πλήρως επενδυμένα με τεχνικό ύφασμα!

Tas ir paredzēts tikai gultām ar noņemamiem pārvalkiem un apaļtārām, kas pilnībā apšūtas ar tehnisko audumu!

Punctul acesta este numai pentru paturi cu acoperire detașabilă și cadru tapițat complet în țesătură tehnică!

Etapp ainult eemaldatavate katetega ja üleni tehnilise kangaga polsterdatud tsargatega vooditeile!

22)

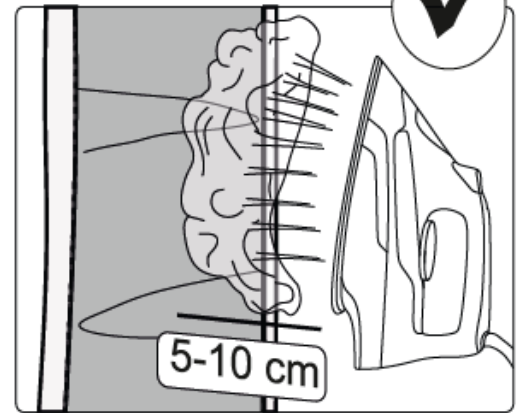
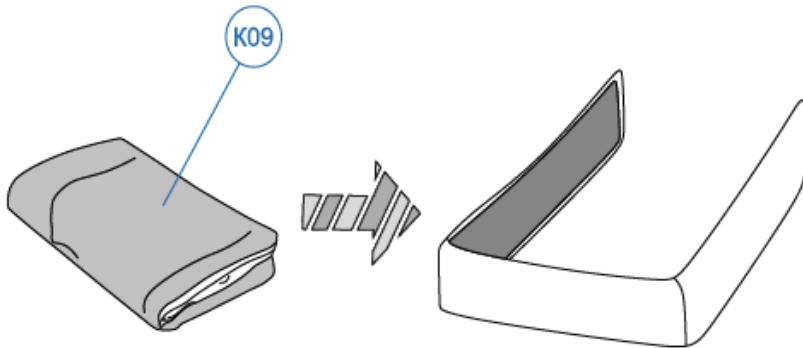

23)

This step refers only to beds with a removable case and rails fully upholstered with technical fabric!

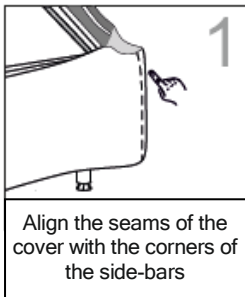

1
Align the seams of the cover with the corners of the side-bars

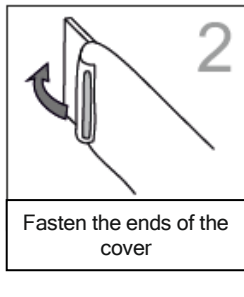

2
Fasten the ends of the cover

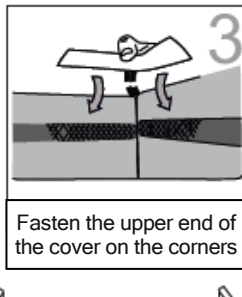

3
Fasten the upper end of the cover on the corners

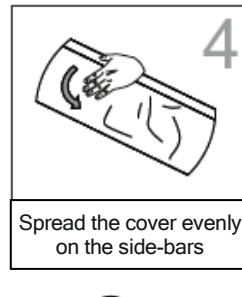

4
Spread the cover evenly on the side-bars

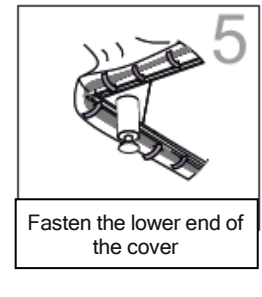

5
Fasten the lower end of the cover

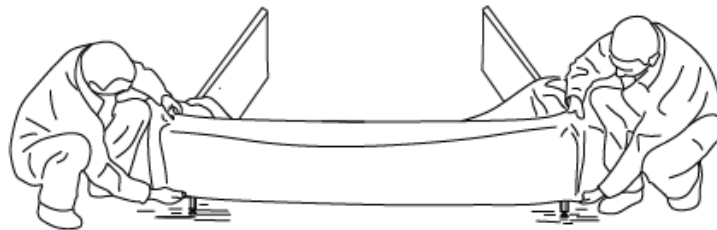

24)

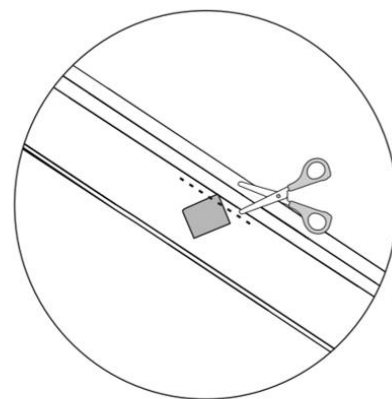
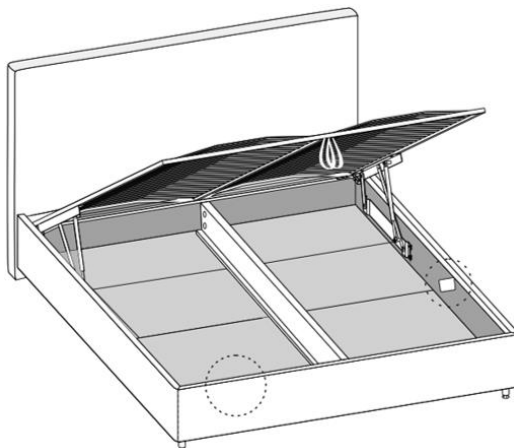

If necessary, the cloth specimen can be cut off or tucked under a removable cover/

Si es necesario, la muestra del material se puede recortar u ocultar debajo de la funda removible /

Uma amostra de material pode ser cortada ou dobrada sob uma tampa removível, se necessário /

Im Falle der Notwendigkeit kann das Stoffmuster abgeschnitten oder in den entfernbaren Bezug gestopft werden /

Εάν είναι απαραίτητο, δείγμα υλικού μπορεί να κοπεί ή να τοποθετηθεί κάτω από το αφαιρούμενο κάλυμμα /

Nepieciešamības gadījumā, materiāla paraugu var nogriezt vai ielikt zem noņemama pārvalka /

Dacă este necesar, un eșantion de țesătură poate fi tăiat sau ascuns sub acoperire detașabilă /

Vajadusel saab kangandist ära lõigata või eemaldada eemaldatava katte alla /

25)

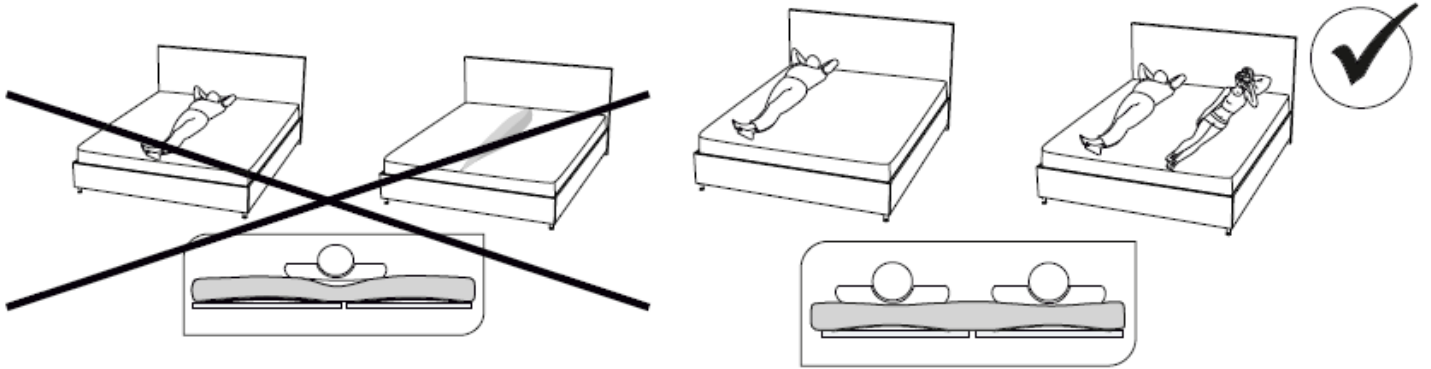

26)

